

Performance Evaluation of Power Weeder in Sugarcane Crop

S. Sai Mohan^{1*}, G. Sanjana², D. Avinash³, M. Rohitha³ and D. Anil Kumar⁴

¹Department of Farm Machinery and Power Engineering, KAU, Kerala, India.

²Department of Process and Food Engineering, GB pant, Uttarakhand, India.

³Agricultural Engineering, PJTSAU, Sangareddy, India.

⁴College of Agricultural Engineering, PJTSAU, Sangareddy, India.

Authors' contributions

This work was carried out in collaboration among all authors. Author SSM designed the study, performed the statistical analysis, wrote the protocol, and wrote the first draft of the manuscript. Author GS managed the analyses of the study and review work. Authors MR and DA managed the literature searches. Author DAK guided during the entire research work. All authors read and approved the final manuscript.

Article Information

DOI: 10.9734/CJAST/2020/v39i3831097

Editor(s):

(1) Dr. Ogunlade, Clement Adesoji, Adeleke University, Nigeria.

Reviewers:

(1) Udokang Anietie Edem, Federal Polytechnic Offa, Nigeria.

(2) Casmir Chidiebere Onyeneke, Hezekiah University, Nigeria.

Complete Peer review History: <http://www.sdiarticle4.com/review-history/63154>

Original Research Article

Received 20 September 2020

Accepted 27 November 2020

Published 12 December 2020

ABSTRACT

Weeding is an important and labour intensive agricultural operation and about 1/3rd of the cost of cultivation is accounted towards weed control operation alone. Any delay and negligence in weeding operation effects the crop yields up to 30-40%. Today the agricultural sector requires non-chemical weed control that safeguards consumers demand for high quality food products and pay special attention to food safety. The objectives of the study was to evaluate the performance of power weeder by evaluating the energy consumption and cost economics of power weeder in sugarcane crop. The evaluation was conducted at soil different moisture contents at 30,45 and 60 days after sowing (DAS) at different speeds of weeder. The bulk density decreased from 0.84 to 0.65 g cm⁻³ with increased soil moisture content from 7±1 to 12±1 per cent. The field capacity of power weeder varied from 0.0347 to 0.137 ha h⁻¹ when operated with 3 forward speeds at 30, 45 and 60 DAS. The weeding efficiency of power weeder is in the range of 98.74 to 91.22% at 0.584 km h⁻¹, 96.80 to 84.93% at 1.35 km h⁻¹ and 94.67 to 73.72% at 4.153 km h⁻¹. The minimum and maximum plant

*Corresponding author: E-mail: samalasaimohan@gmail.com;

damage is observed at a forward speeds of 0.584 km h⁻¹ and 4.153 km h⁻¹. When operated at lower speeds the plant damage will be minimum whereas operating at high speeds will result in maximum plant damage. Field machine index of the weeder is observed as 0.83, 0.82 and 0.864 for 30, 45 and 60 DAS. The cost of weeding per hectare is calculated as Rs.3,878 ha⁻¹ and Rs.8000 ha⁻¹ for mechanical and traditional weeding, respectively. It can be started and operated by farmer or any unskilled labour with ease. Also working with power weeder in between the rows is easy with a very less maintenance cost.

Keywords: Power weeder; field capacity; plant damage; field machine index; cost of weeding.

1. INTRODUCTION

Sugarcane (*Saccharum officinarum*) is the main sugar-producing crop that contributes nearly 78.2% to the total sugar pool at the global level. It is the prime source of sugar in India; also holding the prominent position as the commercial cash crop. It occupies 3.5% (5.04 million hectares) of the total cropped area in the country. Sugarcane industry is a major contributor to the country's economy offering employment to an estimated 6 million Indians.

Doob grass (*Cynodon dactylon*) and Pogan grass (*Imperata cylindrica*) are known to play as alternate hosts to ratoon stunting disease of sugarcane. Thus, weeds essentially harm young sugarcane sprouts by depriving them of moisture, nutrients and sunlight. Poor growth of cane resulting from weed infestation also affects quality. Weeds flora in sugarcane field competes for moisture and light and remove about 4 times N and P & 2.5 times of K during the first 50 days of crop period. In sugarcane crop, weeds are estimated to cause 12 to 72% reduction in cane yield depending upon the severity of infestation [1].

Weeds, which present in the furrows i.e. along the cane rows are more harmful than those present in the inter-row spaces during early crop growth periods. Thus, the initial 90-120 days period of crop growth is considered as most critical period of weed competition. Therefore, the weed management practice should be adopted to ensure a weed-free field condition for the first 3-4 months period [2,3]. Today the

agricultural sector requires non-chemical weed control that safeguards consumers demand for high quality food products and pay special attention to food safety. Through the technical development of mechanisms for physical weed control, such as precise inter and intra-row weeders, it might be possible to control weeds [4]. The weed removal practice in sugarcane crop is mostly carried out manually but there is a need to adopt the mechanical weeding method. So, the study was taken to evaluate the performance of weeder in sugarcane crop [5].

2. MATERIALS AND METHODS

The study was undertaken at farmers' fields in Sangareddy, Telangana state. The power weeder was evaluated at 30, 45 and 60 days after sowing (DAS) and with different forward speeds i.e., 0.584 km h⁻¹, 1.350 km h⁻¹ and 4.153 km h⁻¹ at different moisture content [6]. The details of experimental methodology and measurement techniques adopted during the research were described in the following sections.

2.1 Power Source

Power weeder was used for weeding operation in the sugarcane field. Power weeder is a self-propelled machine with 5.5 HP diesel engine. It is equipped with a set of blades which are mounted on the shaft. The shaft gets the power from engine through transmission. When the shaft rotates blades rotate, the soil is disturbed. The specifications of power weeder were given in Table 1.

Table 1. Specifications of power weeder

S. No	Parts	Specification
1	Engine	5.5 hp diesel (air cooled)
2	Starting system	Recoil
3	Gears	3 forward & 2 reverse
4	P.T.O.	3600 rpm
5	Wheel size	4.0 x 10.0 inches
6	Width of rotavator	66 cm
7	Over all weight	135



Fig. 1. Isometric view of power weeder

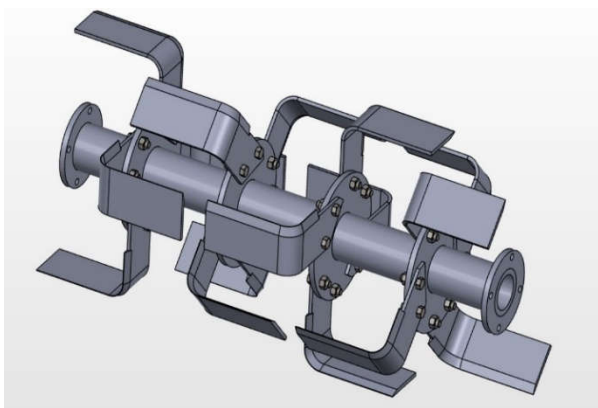

Fig. 2. Blades mounted on shaft and L-blade

2.2 Crop Cultivation

Sugarcane crop was raised as per recommended agronomical practices. Accordingly, plot of 400 m² farm is selected which is situated at 15.54° N latitude and 80.30° E longitude at an altitude of 5 m above sea level located in Fasalwadi thanda, Kandi mandal, Sangareddy district which was sowed in the month of January, 2018. The study area is in sub-tropical climate with hot summers and cool winters with an average rainfall of 854 mm. The soil of the experimental farm is classified as alluvial soil group having sandy loam texture.

2.3 Soil Properties

2.3.1 Moisture content

To determine the soil moisture content, soil samples were taken up to a depth of 100 mm.

The samples were collected randomly from 3 locations before a day of weeding in the field. The samples were weighed and kept in an oven at 105±5°C for 24 h. After drying the sample that collected were weighed on electronic balance. The moisture content of the soil was determined on dry weight basis by using the following formula (*ASOS determination of soil moisture content: oven drying method*):

$$\text{Moisture Content (MC, dry basis)} = \frac{(W1 - W2)}{W2}$$

Where,

MC = Soil moisture content, %

W1 = Initial weight of soil sample, g, and

W2 = Final weight of dry soil sample, g

2.3.2 Bulk density

Bulk density is the ratio of mass of the sample of the material to its occupied volume. The bulk

density of the soil was taken as index of the soil compaction and it was measured before and after the each experiment. The sample thus collected was kept in the hot air oven at a temperature of 105 ± 5 °C for 24 h. The experiment was replicated from different locations and the weight of the dry soil was recorded using electronic balance and the average bulk density was determined by using the following formula (soilquality.org.au):

$$\rho = \frac{M}{V}$$

Where,

ρ = Bulk density of soil, g cm^{-3}

M = Weight of dry soil, g, and

V = Volume of the core cutter, cm^3

2.4 Machine Parameters

2.4.1 Weeding efficiency

It is the ratio between number of weeds removed by power weeder to the number of weeds present in a unit area before weeding operation and is expressed as a percentage [7].

$$W = \frac{W_1 - W_2}{W_1} \times 100$$

Where,

W_1 = Number of weeds present per unit area before weeding operation.

W_2 = Number of weeds counted in same unit area after weeding operation.



Fig. 3. Field view of sugarcane crop at 30 days



Fig. 4. Field evaluation of power weeder



Fig. 5. Field view before and after weeding

2.4.2 Plant damage

It is the ratio of the number of plants damaged after operation in a 10 m row length to the number of plants present before operation in the same length. It is expressed in percentage [8].

$$R = \left(1 - \frac{q}{p}\right) \times 100$$

Where,

R = Plant damaged (%).

p = Total number of plants in 10m row length before the weeding operation.

q = Total number of plants damaged in the same length after the weeding operation.

2.4.3 Actual field capacity

It is the actual area covered by the machine based on its total time consumed and actual working width under field condition [9]. It is expressed as in terms of area covered per unit time of operation. It is calculated by

$$\text{Field capacity (ha h}^{-1}\text{)} = \frac{\text{actual area covered}}{\text{total time consumed}}$$

2.4.4 Theoretical field capacity

Theoretical field capacity (TFC) is a simple calculation involving speed and width with efficiency set at 100%. It can be calculated from the following equation:

$$\text{Theoretical field capacity} = \frac{w \times s}{10}$$

Where,

w = Cutting width, m

s = Speed, km h⁻¹

2.4.5 Effective field capacity

Effective field capacity is the actual average rate of coverage by the machine, based upon the total operation set time. It is a function of the rated width of the machine, the percentage of rated width actually utilized, speed of operation and the amount of field time lost during the operations. Effective field capacity is usually expressed as hectare per hour [10].

$$\text{Effective field capacity} = \frac{\text{Actual field capacity}}{\text{theoretical field capacity}}$$

2.4.6 Performance index of weeder

Performance of the weeder was assessed through performance index (PI) by using the following relation as suggested by Srinivas et al. [11]:

$$PI = \frac{FC \times (100 - PD) \times WE}{p}$$

Where,

FC = Field capacity, ha h⁻¹,

PD = Plant damage %,

WE = Weeding efficiency %, and

P = Power, HP

2.4.7 Field machine index

It is the percentage of total field time, excluding that required for support functions, which is used for productive machine work. The higher the

index the better suited the field for machinery use. For calculating field machine index, total time required to complete one test run and time loss in turning was recorded with the help of stopwatch. The theoretical time required at selected forward speed for 1 ha was calculated. Field machine index (FMI) was calculated as:

$$FMI = \frac{(A-B-C)}{A-B}$$

Where,

A = Total weeding time required to weeding the field, minutes

B = Support functions time including adjusting, cleaning tynes and rest stops

C = Total time spent on turning at row

2.4.8 Fuel consumption

It was measured by top up fill method. The fuel tank was filled to full capacity by placing the machine on a levelled surface before starting of test. After completion of test, amount of fuel required to top up again is the fuel consumption for the test duration. It was expressed in litre per hour.

2.4.9. Energy consumption

The direct energy use per hectare for intercultural operation was computed by the following equation [12]:

$$ED = ED_f + ED_o$$

$$ED_f = h \times AFU \times PEU \times RU$$

$$ED_o = (EIO/T) \times (T/A)$$

Where,

AFU = Average fuel use per working hour ($l\ h^{-1}$),

PEU = Specific energy value per litre of fuel ($MJ\ l^{-1}$)

RU = Number of Runs required for completion of field

EIO = Energy input of operator ($MJ\ h^{-1}$)

T = Time of operation, h

A = Area of operation, ha

ED = Specific direct energy use (fuel) for field operation ($MJ\ ha^{-1}$),

h = Specific working hours per run ($h\ ha^{-1}$)

Human Energy (MJ) = No. of labour \times Energy equivalent (MJ/man-h) \times Time (h)

Diesel Energy (MJ) = Fuel consumption (lit/hr.) \times Energy Equivalent (MJ/lit.) \times time(h) [13]

3. RESULTS AND DISCUSSION

The performance of power weeder for sugarcane crop at different speeds and different stages of crop was evaluated under field conditions.

3.1 Effect of Soil Moisture Content on Bulk Density

Bulk density is an indicator of soil compaction and soil health. It was observed that bulk density was decreased with increased moisture content. The bulk density values were 0.84, 0.76 and 0.65 $g\ cc^{-1}$ at 7 \pm 1, 10 \pm 1 and 12 \pm 1, respectively.

Table 2. Influence of moisture content on bulk density

S.No	Moisture content, %	Bulk Density, $g\ cc^{-1}$
1	7 \pm 1	0.84
2	10 \pm 1	0.76
3	12 \pm 1	0.65

3.2 Effect of Operational Parameters on Field Capacity and Efficiency of the Weeder

The effect of operational parameters on field capacity of the weeder is shown in Fig. 6. The actual field capacity increased with the increase of forward speed, it may be due to more area was covered in less time. The maximum field capacity at 30 DAS was observed as 0.0347 and 0.137 $ha\ h^{-1}$ at 0.584 and 4.153 kmph, respectively. The field capacity was less at 60 DAS when compared with 45 and 30 DAS at all the speeds, it is due to increasing of crop canopy and reducing the area for weeder movement in between the crop rows.

Field efficiency of power weeder was observed to be high at every crop stage when worked at a speed of 0.584 $km\ h^{-1}$ compared to other speeds. It is because there is a less variation between the actual and theoretical field capacity at 0.584 $km\ h^{-1}$. Time lost in turning, removing clods and making adjustments is less at lower speeds. But in case of higher speeds, weeder can't be controlled between the rows and loss of time while making turns will be high that result in lower efficiency of weeder. Operating weeder at high speed in between the rows is not economical and less efficient [14].

3.3 Effect of Machine Operational Parameters on Weeding Efficiency

Effect of machine operational parameters on weeding efficiency was shown in Fig. 2. The maximum weeding efficiency values were observed 98.74, 97.20 and 91.88% at 0.584 kmph for at 30 DAS. From the Fig. 8 the weeding efficiency decreased with increased forward speeds and crop growth increased. At higher speed, the speed of rotary blade was high, which increases the bite length. The weeding efficiency decreased with increasing of operating speed, due to fast moving of machine, reduction in bite length [15]. The same trend was observed at 45 and 60 DAS.

3.4 Effect of Machine Operational Parameters on Plant Damage

The maximum plant damage was observed as 16.77% and minimum plant damage was 0.94% at 60 and 30 DAS, respectively. The plant damage was increased with increase of forward speed and plant growth; [16] it is due to increase of canopy area. When the power weeder operates at high speed, the operator cannot control of machine movement on to the plants and high impact action of the rotary tynes to the tender plant stem. Among three different days of intervals, plant damage at 60 DAS was found to be highest due to spreading of crop roots widely and covering of rows with canopy. Power weeder should be operated at lowest speed for lowest plant damage.

3.5 Effect of Machine Operational Parameters on Performance Index

Performance index of the weeder is directly related to the field capacity, plant damage, and weeding efficiency and inversely related to power exerted. It was observed that the performance index increased with the increase of forward speed.

3.6 Effect of Machine Operational Parameters on Field Machine Index

Field machine index values were varied in the range of 0.69 to 0.91. Generally, field machine index must be more than 0.70 for suitability of any crop for weeding. Hence, the machine was suitable for weeding operation in the sugarcane crop.

3.7 Fuel Consumption

Fuel consumption was measure by top method. Machine was operated for continuous 1 hr and a fuel consumption of 250 ml was observed.

3.8 Energy Consumption

The direct use of energy per hectare for weeding operation by power weeder was estimated at different intervals of crop period. Energy consumption for weeding operation at different intervals is shown in Tables 3 and 4.

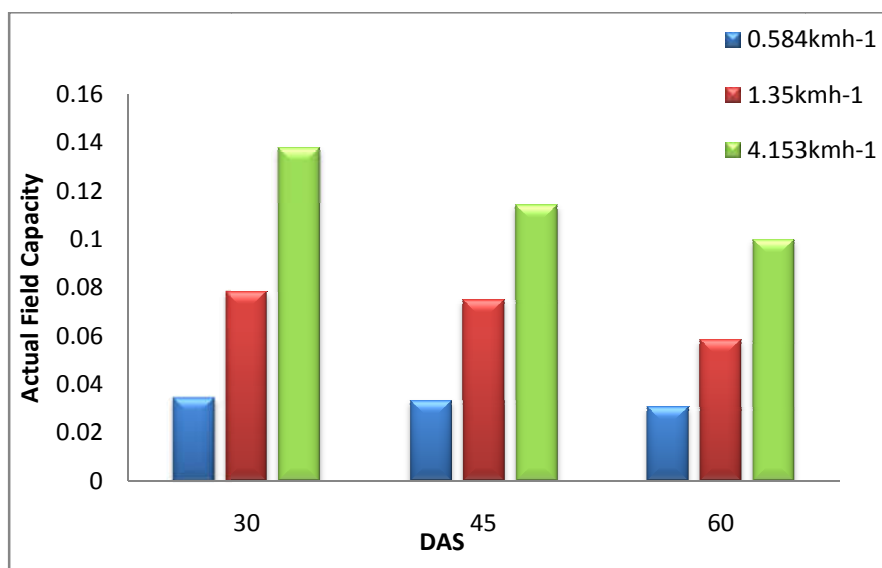

Fig. 6. Effect of operational parameters on field capacity of the weeder

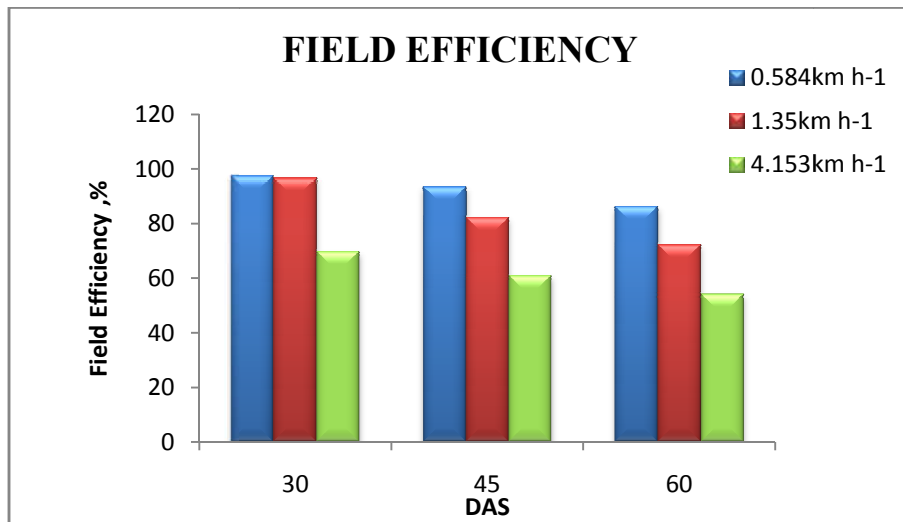

Fig. 7. Effect of operational parameters on field efficiency of the weeder

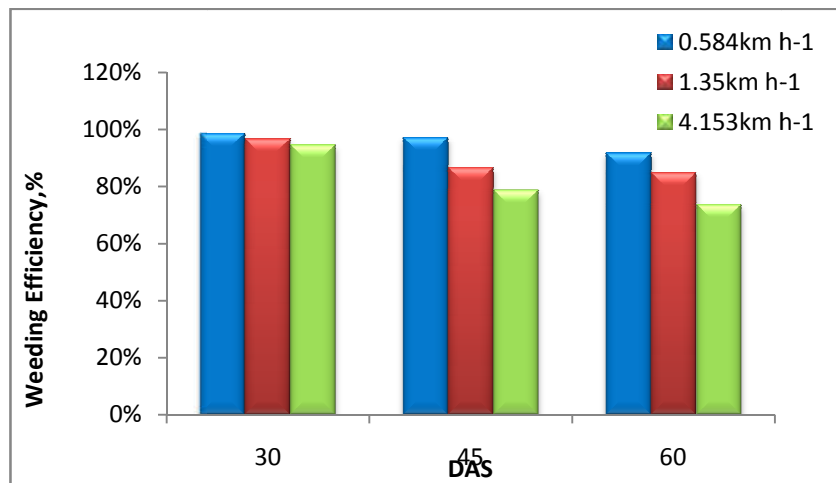

Fig. 8. Effect of machine operational parameters on weeding efficiency

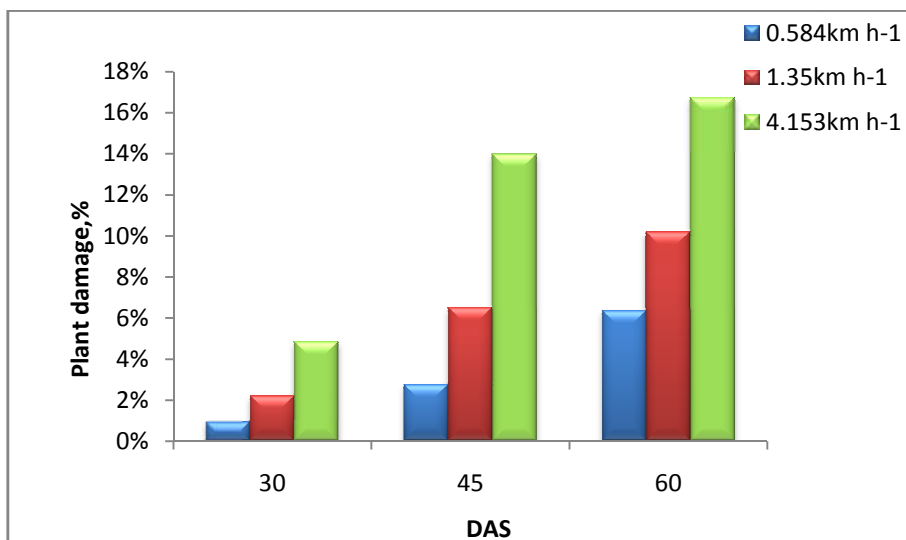

Fig. 9. Effect of machine operational parameters on plant damage

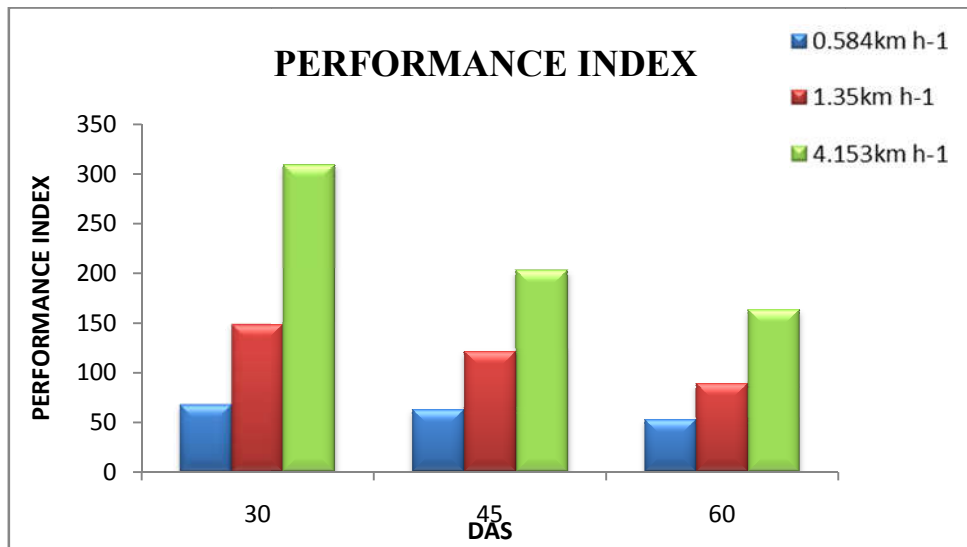

Fig. 10. Effect of machine operational parameters on performance index

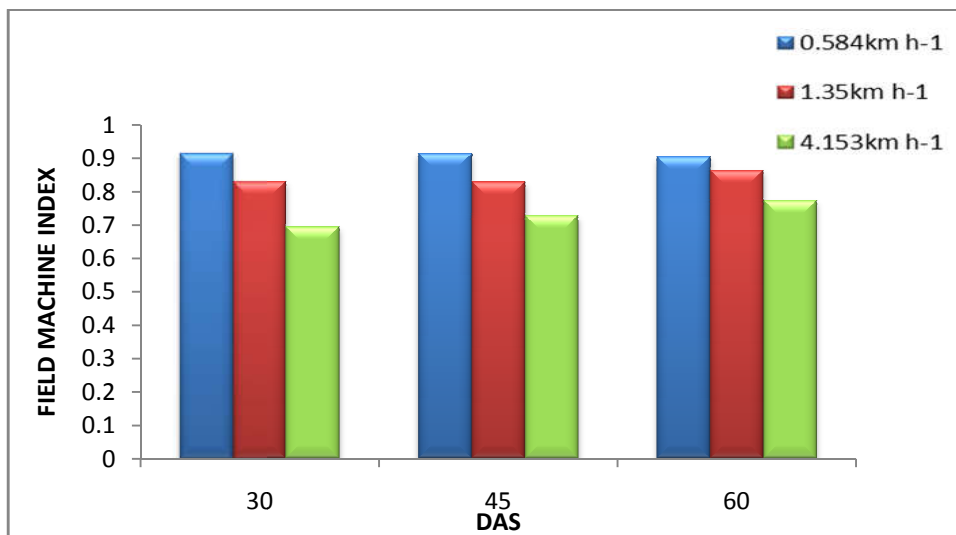

Fig. 11. Effect of machine operational parameters on field machine index

From the Table 3, it is observed that, the energy consumption for weeding operation at 1.35 km h⁻¹ forward speed of power weeder was observed in the range of 602.64 to 632.42 MJ ha⁻¹. Among the different intervals of time, energy consumption at 60 DAS was highest i.e. 632.42 MJ ha⁻¹ followed by 45 DAS and 30 DAS i.e. about 620.74 and 602.64 MJ ha⁻¹, respectively.

Energy consumption at initial stages of plant is less because of obstruction free travel between the rows. Whereas in case of a grown field, it is difficult to travel between the rows and as a result energy consumption was higher.

3.9 Cost Economics of Power Weeder Operation

The power weeder was evaluated for the estimation of cost of operation and compared with traditional method of weeding. Cost of operation was calculated by fixed cost and variable cost of machine. The cost of operation for mechanical weeding and traditional method were Rs.3,878 ha⁻¹ and 8,000 ha⁻¹ respectively. Cost of weeding may be saved with mechanical weeding about Rs.4,122 ha⁻¹ when compared to traditional method.

Table 3. Human energy consumed at different stages of crop

Speed, km h ⁻¹	Human energy (MJ)		
	30 DAS	45 DAS	60 DAS
0.584	30.12	31.27	33.95
1.35	13.33	13.92	17.84
4.153	7.58	9.150	10.46

3.9.1 Cost economics of weeding with power weeder

Total cost of weeding operation = Rs. 800 / day
 Total cost of operation per hectare= Rs. 8000/ ha

Cost incurred in weeding operation in mechanical method was calculated and tabulated in Table 5.

Also cost and time of operation increases as the DAS increase. The dense canopy prevents easy working of weeder between the rows and increases the duration of weeding. As the duration of weeding increases, the field efficiency of weeder decreases as a result of increased working hours [17]. So, the number of tynes has to be decreased to prevent plant damage and also to increase weeding efficiency [18].

3.9.2 Cost economics of weeding with traditional method

Labour charge = Rs. 50 hr⁻¹
 Cost of labour (4 workers, 8 hrs/day)= Rs. 800/ day
 Total area that is weeded in a day= 1000 m² (approx)

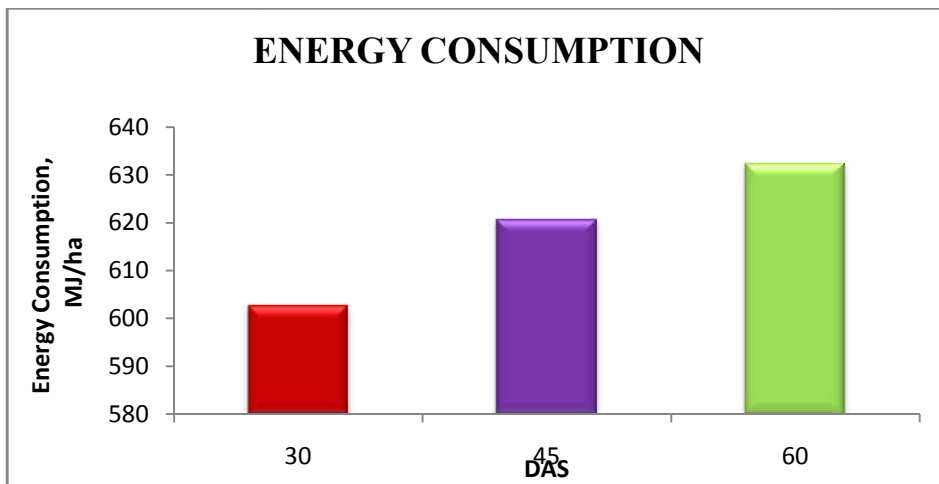

Fig. 12. Energy consumption at different intervals of time

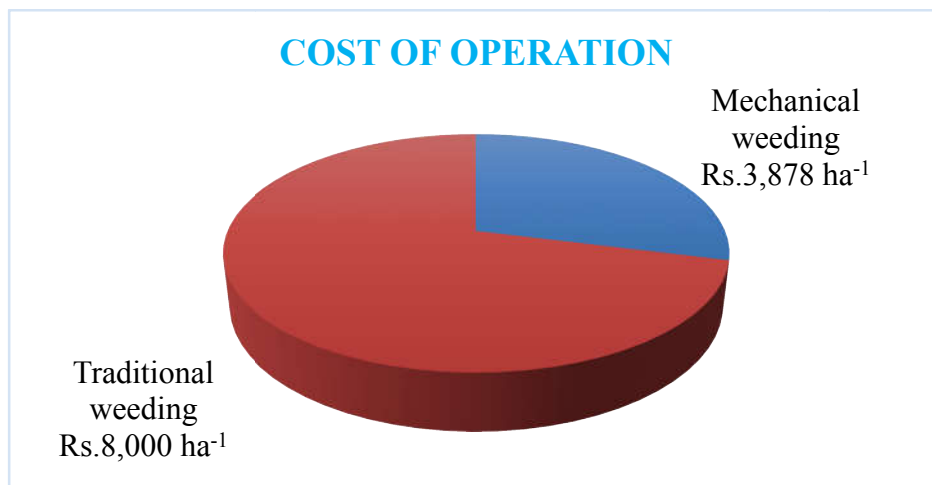

Fig. 13. cost economics of power weeder operation

Table 4. Energy consumption of weeding at different stages of crop

DAS	Energy Consumption in Sugarcane, MJ ha ⁻¹
30	602.64
45	620.74
60	632.42

Table 5. Cost of operation of weeding with power weeder

S. no.	Parameter	Considerations	Operation with Power weeder
Fixed cost (Rs/h)			
1	Initial cost (Rs.)	1,50,000	-
2	Salvage value (Rs.)	10 %	-
3	Expected life (yr)	10	-
4	Annual working hours (h)	300	-
5	Depreciation (Rs.)	-	45
6	Interest (Rs.)	-	27.5
7	Housing + Taxes + Insurance (Rs.)	3 %	15
Variable cost (Rs/h)			
9	Repairs cost (Rs.)	30 % of IC	150
10	Fuel cost (Rs.)	0.25 l/hr	17.5
11	Lubricants (Rs.)	30 % of fuel cost	5.25
	➤ Cost of weeding	= 45+27.5+15+150+17.5+5.25+50 =	Rs. 310.25 hr ⁻¹
	➤ Field capacity, ha hr ⁻¹	= 0.08 ha hr ⁻¹	
	➤ Cost of operation Rs ha ⁻¹	= Rs. 3,878.12 ha ⁻¹	

4. CONCLUSION

Power weeder was evaluated for its performance in sugarcane crop. This test was conducted at different moisture contents of soil observed at 30, 45 and 60 DAS and different speeds of weeder. The bulk density decreased from 0.84 to 0.65 g cm⁻³ with increased soil moisture content from 7±1 to 12±1 percent. The field efficiency of power weeder was high when operated at 4.153 km h⁻¹ during initial crop growth and gradually decreases with increasing DAS. The weeding efficiency of power weeder was observed to be high at every stage of crop with varying speeds. When operated at lower speeds the plant damage will be minimum whereas operating at high speeds will result in maximum plant damage. The cost of weeding per hectare was observed as Rs.3,878 ha⁻¹ and Rs.8,000 ha⁻¹ for power weeding and traditional weeding, respectively. It can be started and operated by farmer or any unskilled labour with ease. Also working with power weeder in between the rows is easy with a very less maintenance cost.

COMPETING INTERESTS

Authors have declared that no competing interests exist.

REFERENCES

- Handbook of Agriculture. 1 ed. Indian Council of Agri. Research-New Delhi; 2012.
- Padole YB. Performance evaluation of rotary power weeder. *Agricultural Engineering Today*. 2007;31(3&4):30-33.
- Rangaswamy K, Balasubramanian M, Swaminathan KR. Evaluation of power weeder performance. *Agricultural mechanization in Asia, Africa and Latin America*. 1993;24(4):16-18.
- Blasco J, Aleixos N, Roger JM, Rabatel G, Molto E. Robotic weed control using machine vision. *Biosyst. Eng.* 2002;83(2): 149–157.
- Melander B. Non-chemical weed control: new directions in. In: *Encyclopedia of Plant and Crop Science* Marcel Dekker, New York, USA; 2004. Available: <http://www.dekker.com>
- Nagesh Kumar T, Sujay Kumar A., Madhusudan N, Ramya V. Performance evaluation of weeders. *International Journal of Science and Technology*. 2014; 3(6):2160–2165.
- Tiwari VK, Chandel NS, Vidhu KP, Tripathi H. Performance evaluation and scope of adoption of rotary power weeder in

- vegetable crops. *Agricultural Engineering Today*. 2014;38(3):10-14.
8. Singh SK, Devi AA. Effect of grasses fed to pigs by different methods on their growth rate and feed conversion efficiency. *Indian J. Anim. Sci.* 1998;68(7):693-695.
 9. Olaoye JO, Adekanye TA. Development and evaluation of a rotary power weeder. *Proc. Nige. Soc. Agric. Engg.* 2011;3:189-199.
 10. Kepner RA, Bainer R, Barger EL. *Principles of farm machinery* (3rd Ed.). CBS Publishers & Distributors Pvt. Ltd., New Delhi. 2005;23.
 11. Srinivas I, Adake RV, Reddy BS, Korwar GR, Thyagaraj CR, Dange A. Comparative performance of different power weeders in rain fed sweet sorghum crop. *Indian Journal of Dry land Agriculture Research and Development*. 2010;25:63-67.
 12. Karale DS, Khambalkar SM, Bhende SM, Sharddha BA, Wankhede PS. Energy economic of small farming crop production operations. *World J. Agric. Sci.* 2008;4(4): 476-482.
 13. Yadav R, Pund S. Development and ergonomic evaluation of manual weeder. *Agricultural Engineering International: The CIGR E Journal*. 2007;9:1-9.
 14. Tajuddin A. Design, development and testing of engine operated weeder. *Agricultural Engineering Today*. 2006; 30(5,6):25-29.
 15. Benny JM, Khoo DCP. Preliminary investigations into the performance of different shaped blades for the rotary tillage of wet rice soil. *J. Agric. Eng. Res.* 1970;15(1):27-33.
 16. Lotz L, Van DWRY, Horeman GH, Joosten LTA. Weed management and policies: From prevention and precision technology to certifying individual farms. In: *Proceedings, 12th European Weed Research Society Symposium, Wageningen*. 2002;2-3.
 17. Monayem Mlah MA, Enamul Haque Md, Israll Hossain. Economic analysis of power tiller operated seeder operation at field level. *Journal of Agricultural Engineering*. 2010;38/AE.
 18. Tiwari VK, Datta RK, Murthy SR. Field performance of weeding blades of manually operated push-pull weeder. *Journal of Agricultural Engineering*. 1993; 55:129-141.

© 2020 Mohan et al.; This is an Open Access article distributed under the terms of the Creative Commons Attribution License (<http://creativecommons.org/licenses/by/4.0>), which permits unrestricted use, distribution, and reproduction in any medium, provided the original work is properly cited.

Peer-review history:

The peer review history for this paper can be accessed here:
<http://www.sdiarticle4.com/review-history/63154>